

10 Metal Puzzle - Red



Objective of the Puzzle: Disassemble and reassemble.

Manufacturer: Eureka

Difficulty: Level 6-9 (out of 10)



®



© Eureka bvba 2015
2800 Mechelen, Belgium
All rights reserved

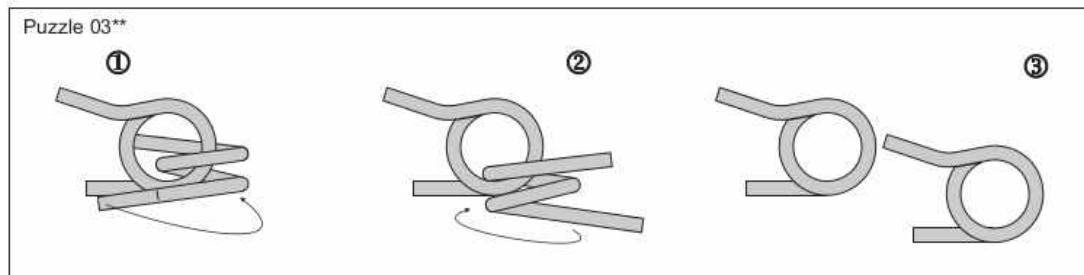
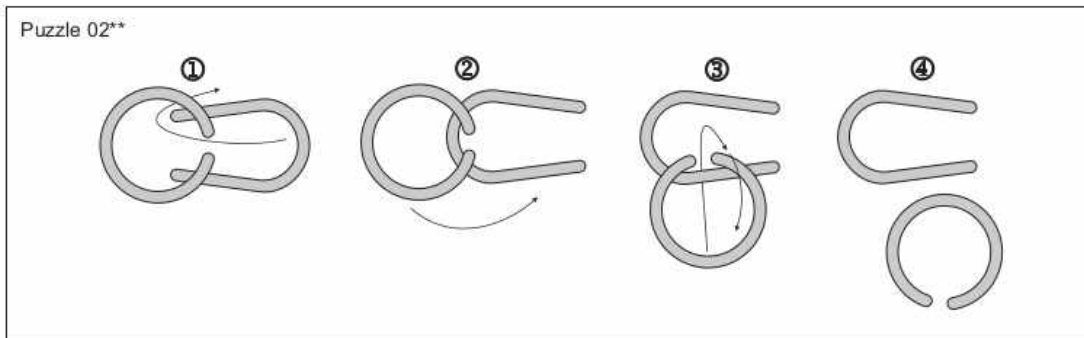
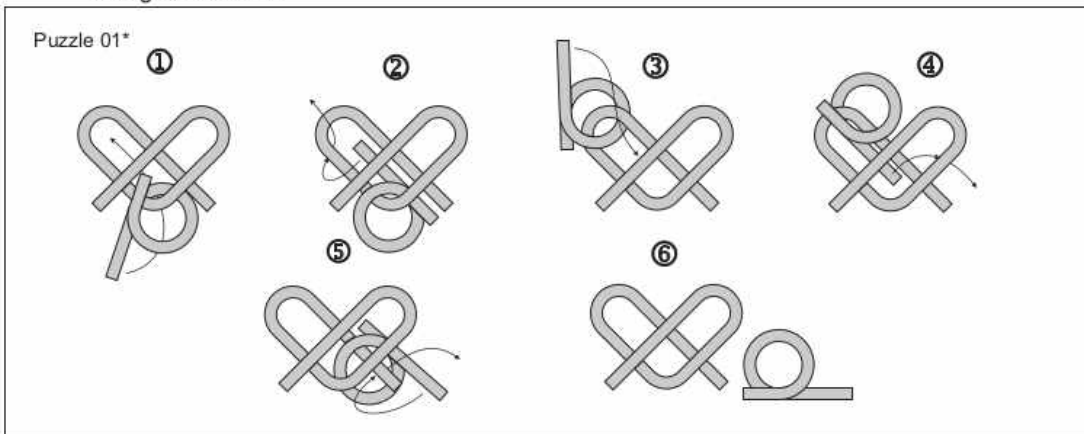

10 Metal Puzzle - Red



Objective of the Puzzle: Disassemble and reassemble.

Manufacturer: Eureka

Difficulty: Level 6-9 (out of 10)

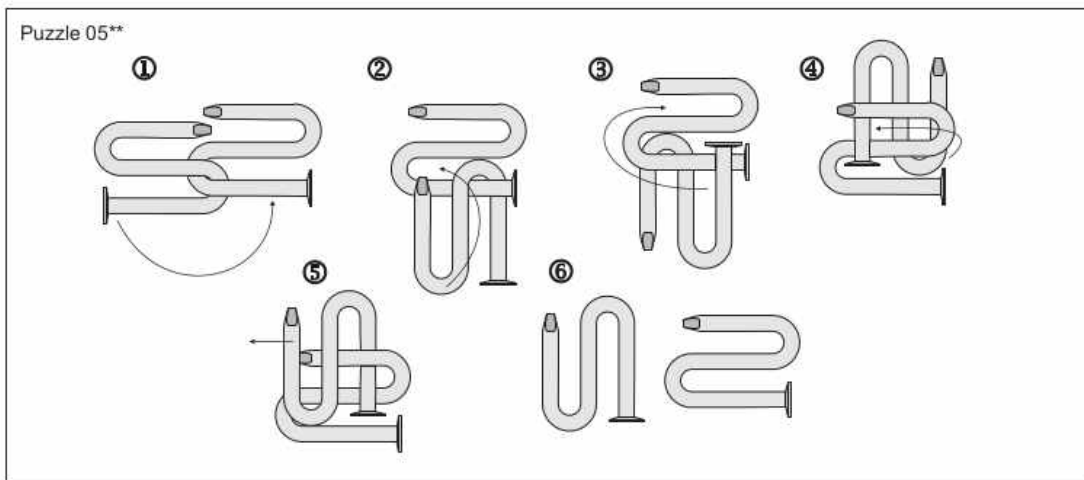
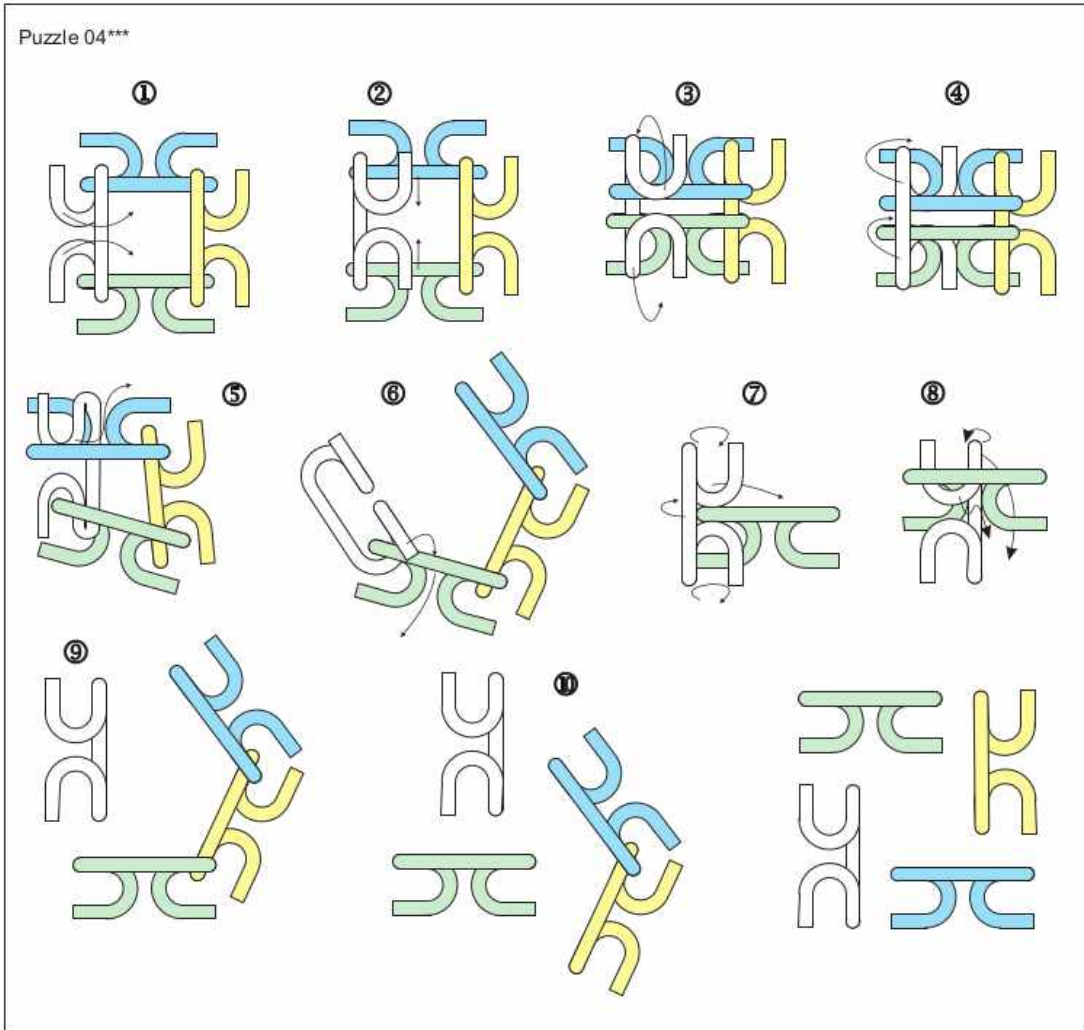

10 Metal Puzzle - Red



Objective of the Puzzle: Disassemble and reassemble.

Manufacturer: Eureka

Difficulty: Level 6-9 (out of 10)

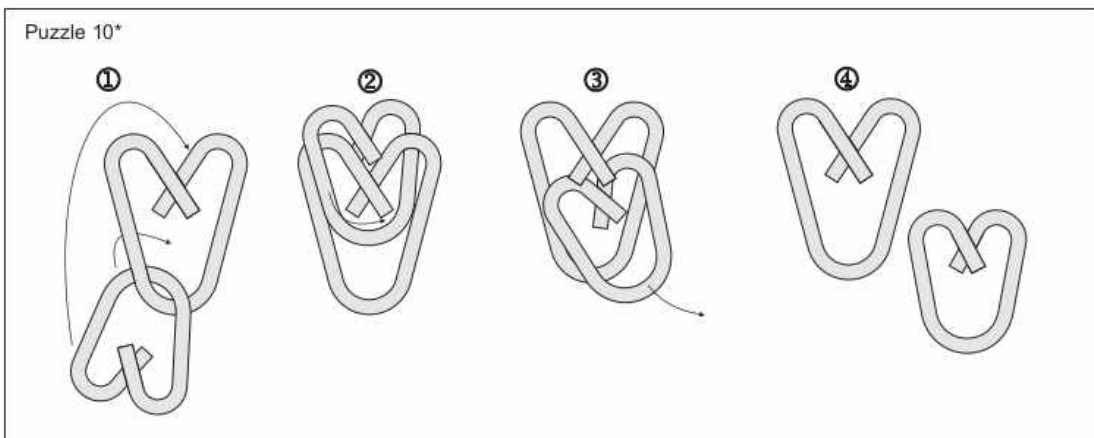
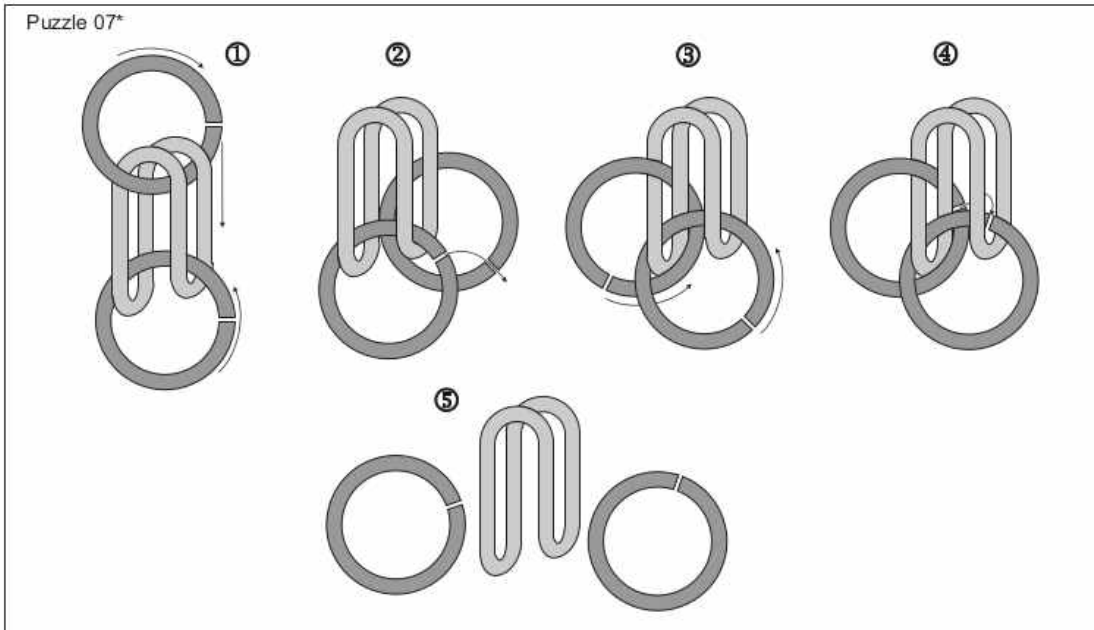
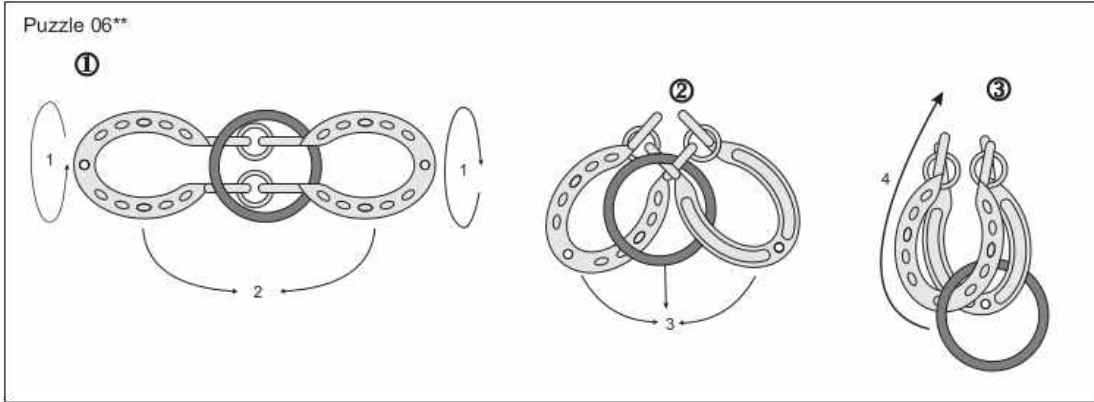

10 Metal Puzzle - Red



Objective of the Puzzle: Disassemble and reassemble.

Manufacturer: Eureka

Difficulty: Level 6-9 (out of 10)

